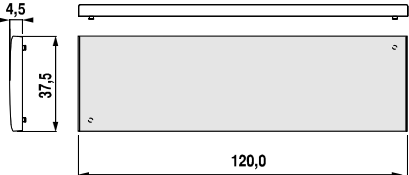
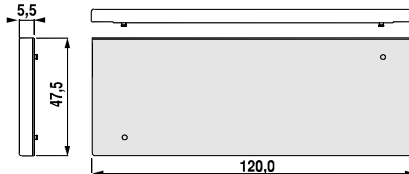
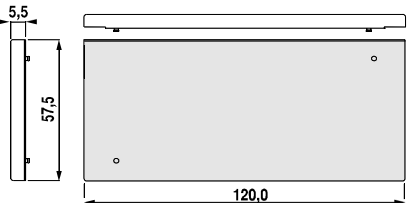
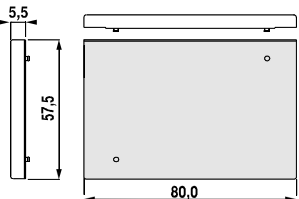
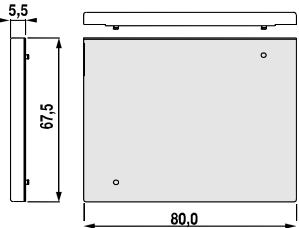

PRISLISTE 01.07.2001
VARMEPLADER OG TILBEHØR

	Nr.	Beskrivelse	Vægt kg.
REXLAN standard polymerbeton varmeplader til indbygning i plastriste med 40/50 cm mellem understøtningerne			
Til farestier			
	503413	120x37,5x4,5 cm, varmt vand (WRF-0140)	41
	513744	120x37,5x4,5 cm, 230V, 150 W (ERF-0215)	41
	503397	120x47,5x5,5 cm, varmt vand (WRF-0142)	57
	524715	120x47,5x5,5 cm, 230V, 150 W (ERF-0188)	55
	512525	120x57,5x5,5 cm, varmt vand (WRF-0171)	65
		120x57,5x5,5 cm, 230V, 180 W (ERF-0189)	60
	503428	80x57,5x5,5 cm, varmt vand (WRF-0143)	47
	513435	80x57,5x5,5 cm, 230V, 150 W (ERF-0190)	47
	523553	80x67,5x5,5 cm, varmt vand (WRF-0166)	52
	503222	80x67,5x5,5 cm, 230V, 150 W (ERF-0152)	52

PRISLISTE 01.07.2001
VARMEPLADER OG TILBEHØR

Nr. Beskrivelse

Vægt
kg.

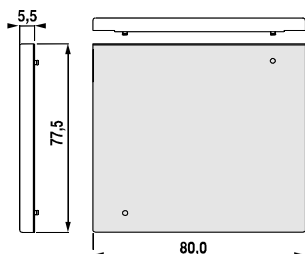

- 504845 80x77,5x5,5 cm, varmt vand (WRF-0191)
 503223 80x77,5x5,5 cm, 230V, 150 W (ERF-0150)

58
58

**Indbygning med plastbeslag
 15 mm over gulvniveau:**

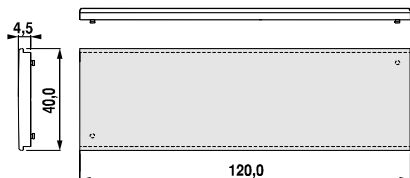

- 503285 120x40x4,5 cm, varmt vand (WRF-072)
 503284 120x40x4,5 cm, 230V, 150 W (ERF-071)

44
32

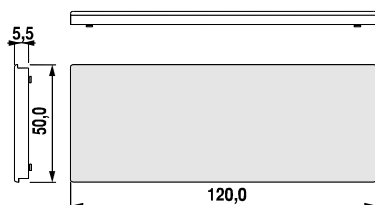

- 503301 120x50x5,5 cm, varmt vand (WRF-078)
 503303 120x50x5,5 cm, 230V, 150 W (ERF-089)

59
59

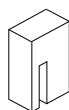

- WRB-007 Plastik montage beslag
 4 stk per plade

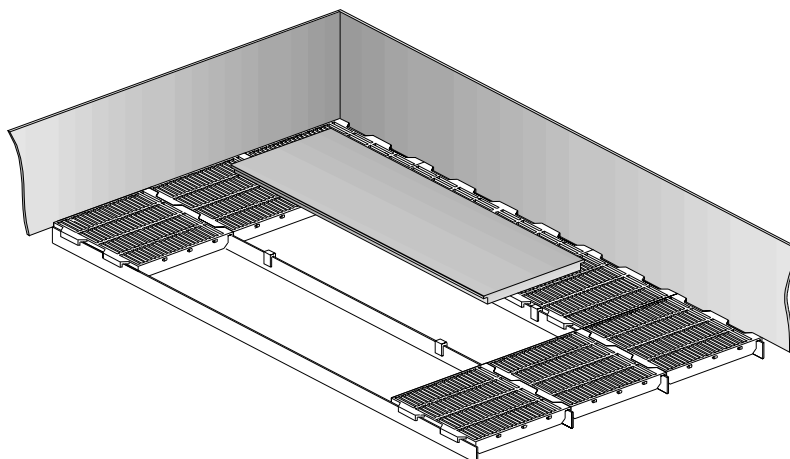

PRISLISTE 01.07.2001
VARMEPLADER OG TILBEHØR

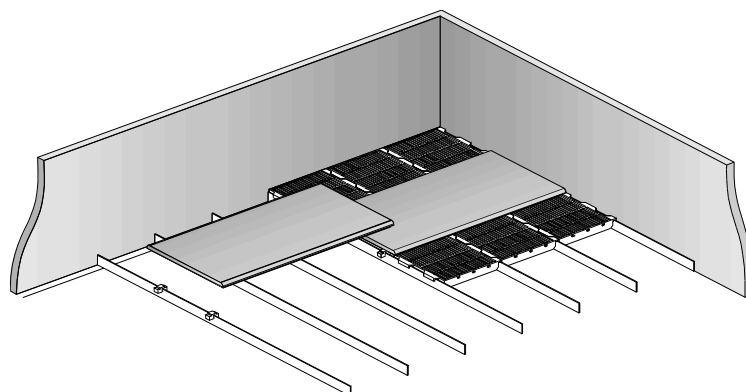
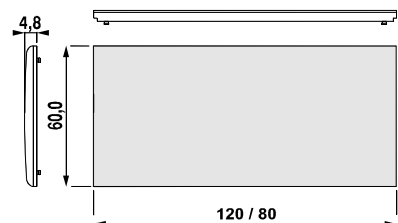
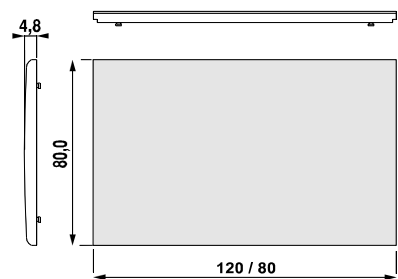

Nr.	Beskrivelse	Vægt kg.
Til klimastier:		
503251	120x80x5,3 cm, varmt vand (WRP-033)	101
512517	100x80x5,3 cm, varmt vand (WRP-0185)	86
503244	80x80x5,3 cm, varmt vand (WRP-056)	75
515039	50x80x5,3 cm, varmt vand (WRP-0236)	46,5
503314	120x80x5,3 cm, 230V, 220 W (ERP-065)	83
515035	100x80x5,3 cm, 230V, 180 W (ERP-0225)	70
503351	80x80x5,3 cm, 230V, 150 W (ERP-095)	55
515030	50x80x5,3 cm, 230V, 110 W (ERP-0226)	35
503306	120x60x4,8 cm, varmt vand (WRP-013)	69
515042	100x60x4,8 cm, varmt vand (WRP-0237)	56
503346	80x60x4,8 cm, varmt vand (WRP-054)	45
515038	50x60x4,8 cm, varmt vand (WRP-0238)	28
503234	120x60x4,8 cm, 230V, 180 W (ERP-0155)	48
515034	100x60x4,8 cm, 230V, 150 W (ERP-0227)	42
503226	80x60x4,8 cm, 230V, 110 W (ERP-0156)	34
515029	50x60x4,8 cm, 230V, 110 W (ERP-0229)	21

PRISLISTE 01.07.2001
VARMEPLADER OG TILBEHØR

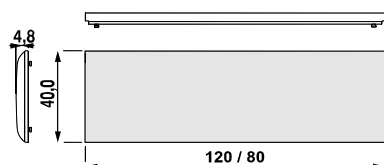
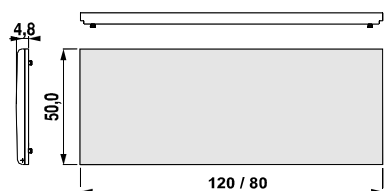

Nr.	Beskrivelse	Vægt kg.
503296 (WRP-010)	120x50x4,8 cm, varmt vand	54
515041 (WRP-0239)	100x50x4,8 cm, varmt vand	45
503343 (WRP-011)	80x50x4,8 cm, varmt vand	37
515038 (WRP-0238)	50x50x4,8 cm, varmt vand	28
503231 (ERP-0231)	120x50x4,8 cm, 230V, 150 W	45
515033 (ERP-0233)	100x50x4,8 cm, 230V, 150 W	38
515031 (ERP-0234)	80x50x4,8 cm, 230V, 110 W	30
515028 (ERP-0235)	50x50x4,8 cm, 230V, 110 W	19
503288 (WRP-031)	120x40x5,3 cm, varmt vand	54
515040 (WRP-0241)	100x40x5,3 cm, varmt vand	45
503252 (WRP-032)	80x40x5,3 cm, varmt vand	32
515036 (WRP-0242)	50x40x5,3 cm, varmt vand	23
503225 (ERP-0149)	120x40x5,3 cm, 230V, 150 W	45,5
515032 (ERP-0230)	100x40x5,3 cm, 230V, 150 W	38
503237 (ERP-0158)	80x40x5,3 cm, 230V, 110 W	27,5
515027 (ERP-0232)	50x40x5,3 cm, 230V, 110 W	19
WRB-000	Plastk montagebeslag 2 per plade + 2 til endepladen	

PRISLISTE 01.07.2001
VARMEPLADER OG TILBEHØR

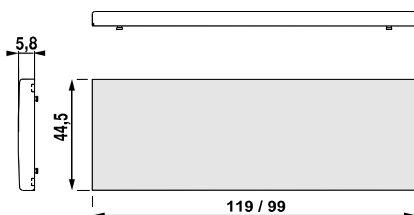
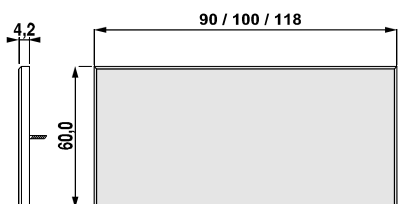
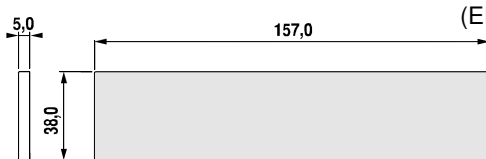
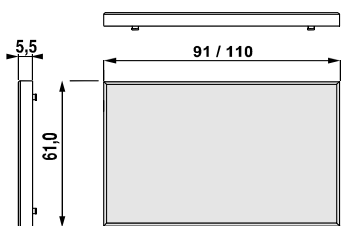
	Nr.	Beskrivelse	Vægt kg.
		REXLAN standard polymerbeton varmeplader til indbygning i ristegulve, tilmontage ovenpå gulve eller til indbygning i faste betongulve:	
	503275	119x44,5x5,8 cm, varmt vand (WRF-027)	54
	503276	119x44,5x5,8 cm, 230V, 150 W (ERF-028)	50
	503371	99x44,5x5,8 cm, varmt vand (WRF-025)	49,5
	503224	99x44,5x5,8 cm, 230V, 150 W (ERF-0131)	42
		90x60x4,2 cm, 230V, 150 W	38
	503131	100x60x4,2 cm, 230V, venstre, 150 W	42
	503130	100x60x4,2 cm, 230 V, højre, 150 W	42
	513760	118x60x4,5 cm, 230V, venstre, 150 W	49
	513759	118x60x4,5 cm, 230 V, højre, 150 W	49
	513436	160x38x4,8 cm, 230V, 150 W (ERF-0209)	50
		91x61x5,5 cm, varmt vand	50
	515577	110x61x5,5 cm, varmt vand	63,5

PRISLISTE 01.07.2001
VARMEPLADER OG TILBEHØR

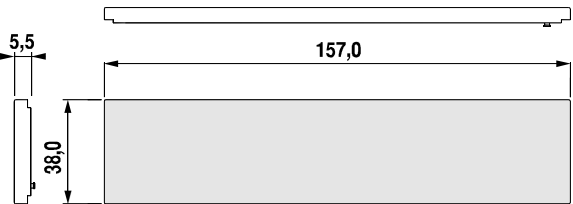
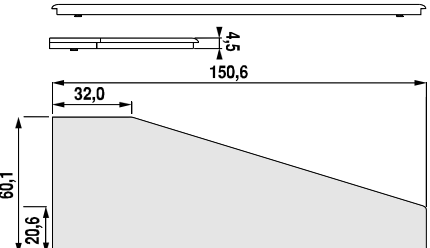
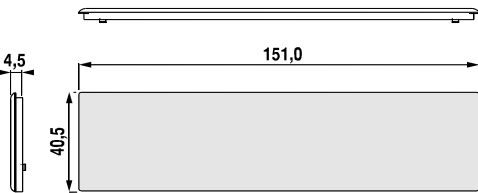
	Nr.	Beskrivelse	Vægt kg.
	513472 (WRF-0211)	160x38x4,8 cm, varmt vand	61
			
	513456 (WRF-0206)	150x60 (30/21) cm, varmt vand, højre	60
			
	513457 (WRF-0207)	150x60 (30/21) cm, varmt vand, venstre	60
	513432 (ERF-0204)	150x60 (30/21) cm, 230V, højre, 220 W	51
	513433 (ERF-0205)	150x60 (30/21) cm, 230V, venstre, 220 W	51
	506488 WRF-0199	151x40,5 cm, varmt vand	55,5
			
	513005 (ERF-0198)	151x40,5 cm, 230V, 180 W	46
	513757 (WRF-0255)	135x60 (48/32) cm, varmt vand, højre	60
	524785 (WRF-0256)	135x60 (48/32) cm, varmt vand, venstre	60
	524779 (ERF-0253)	135x60 (48/32) cm, 230 V, højre, 220W	51
	524783 (ERF-0254)	135x60 (48/32) cm, 230 V, venstre, 220 W	51
	526582 (WRF-0259)	95x(80/15)x4,5 cm, varmt vand, højre	54
	526584 (WRF-0260)	95x(80/15)x4,5 cm, varmt vand, venstre	54
	526579 (ERF-0257)	90x(80/15)x4,5 cm, 230 V, højre, 150 W	40
	526581 (ERF-0258)	90x(80/15)x4,5 cm, 230 V, venstre, 150 W	40

PRISLISTE 01.07.2001
VARMEPLADER OG TILBEHØR

	Nr.	Beskrivelse	Vægt kg.
	512523	119x99x30x5,5 cm, varmt vand, højre (WRF-0175)	78
	512524	119x99x30x5,5 cm, varmt vand, venstre (WRF-0174)	78
	515043	119x99x30x5,5 cm, 230V, højre, 220 W (ERF-0176)	78
	515044	119x99x30x5,5 cm, 230V, venstre, 220 W (ERF-0177)	78
		503432	100x92x34x5,5 cm, varmt vand, højre (WRP-0162)
503431		100x92x34x5,5 cm, varmt vand, venstre (WRP-0163)	62
503227		100x92x34x5,5 cm, 230V, højre, 150 W (ERP-0164)	62
503228		100x92x34x5,5 cm, 230V, venstre, 150 W (ERP-0165)	62

PRISLISTE 01.07.2001
VARMEPLADER OG TILBEHØR

Nr. Beskrivelse

Vægt
kg.

POLY-REX el- og vandplader

Til farestier:

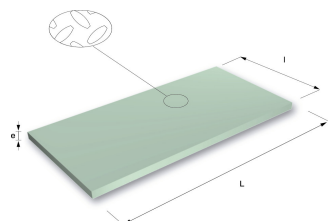

503398 100x50x3,5 cm, varmt vand
(PRW-0134)

30

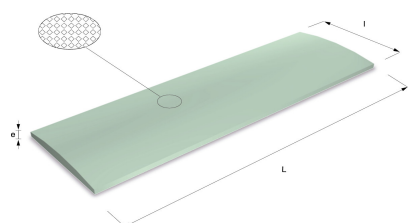

503389 120x37,5x4,2 cm, varmt vand
(PRW-0153)

30

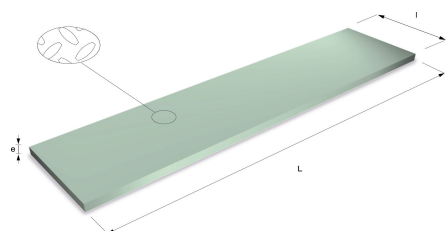

512903 120x47,5x3,5 cm, varmt vand
(PRW-0194)

32

512408 120x47,5x3,5 cm, 230V, 180 W
(PRE-0196)

32

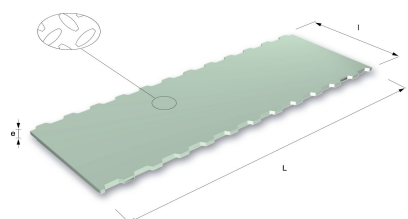

513471 160x38x3,5 cm, varmt vand
(PRW-0210)

40

516783 120x40x3,5 cm, med pasform til
standard plastriste, varmt vand
(PRW-0243)

26

521992 120x40x3,5 cm, med pasform til
standard plastriste, 230 V, 180 W
(PRE-262)

26

PRISLISTE 01.07.2001
VARMEPLADER OG TILBEHØR

Nr. Beskrivelse

Vægt
kg.

Til klimastier:

- 513449 120x50x3,5 cm, varmt vand
(PRW-0184)
 512404 120x50x3,5 cm, 230V, 180 W
(PRE-0195)

32

32

**Til farestier, specialmodel til montage direkte
 ovenpå gulv, med tilslutning på oversiden:**

- 503388 100x60x2,8 cm, varmt vand
(PRW-0129)
 507287 Montagebeslag, rustfri stål

30

